



Sustainable Solutions to Hard Water

Installation & Operations Manual

SB-250, SB-350, SB-450 & SB-650



Commercial Electronic Descaler
115/230 VAC (Auto Selected)



Sustainable Solutions to Hard Water

Commercial - 5 YEAR LIMITED WARRANTY

All commercial **ScaleBlaster**® electronic descaler products carry a full **five (5) year warranty** to be free from defects in material and workmanship under normal use from the date of purchase. In the event of malfunction or failure of this product, the purchaser should contact their dealer for service. If dealer is unavailable, contact **Clearwater Enviro Tech** direct at **800-756-7946 or 727-562-5186** or by fax **727-562-5187** or going to their website at **clearwater-enviro.com** to obtain an **RMA (return merchandise number)**. Properly package the entire unit and ship it prepaid with a note containing the RMA number, your name, address, phone number (or best way to contact you) along with a brief description of the difficulty you are experiencing with the unit to:

Clearwater Enviro Technologies, Inc. • 8767 115th Ave. N. • Largo, FL 33773

Please be sure to also write the **RMA** number on the outside of the shipping box.

If the malfunction or failure is a result of defects covered by this warranty, **Clearwater Enviro Tech** will repair the product or replace it and return it to the purchaser. After a period of **five years**, a small labor and parts charge will occur.

This warranty is limited to the original retail purchaser and is not transferable. This warranty does not cover damage due to accidents, abuse, tampering, misuse, fire, lightning damage, power surge, flooding or any catastrophic acts of God.

This warranty does not extend to any other electrical or water appliance or device.

In no event shall the manufacturer be liable for damages from improper user installation, nor shall they be liable for already damaged pipe and any consequential damages incurred, whether direct or indirect.

This warranty is limited to repair or replacement and does not include consequential damage or installation expenses and is in lieu of all other warranties express or implied. This warranty gives you specific rights and you may also have other rights, which vary from state to state.

ScaleBlaster.com

Table of Contents

Section	Description	Page
	Product Warranty Information.....	2
A)	Identifying the Scaleblaster [®] Components.....	3
B)	Tools and Materials Required.....	3
C)	Site Survey.....	4, 5
D)	Mounting the Power Box.....	6
E)	Installing the Signal Cable.....	6, 7
F)	Powering up the Control Box / Computer.....	8
G)	LCD Indicator Screen.....	8

A.) Identifying the ScaleBlaster[®] Components

This ScaleBlaster[®] unit includes the following components:

- 1) One **ScaleBlaster** control box.
- 2) **One roll of 18 gauge (SB-250) or 12 gauge (SB-350, SB-450 and SB-650) signal wire.** (length to be determined by specific application, pipe size, and pipe material.)
- 3) **Three long nylon cable ties.** These ties aid in securing the cable to the pipe.
- 4) **Warranty card (along with this Installation & Operations Manual)**
- 5) **Shipping Box.** Please save the foam inserts and shipping box, it is made to protect the descaler during transport and is reusable in case the unit ever needs servicing at the factory.

SB-250, SB-350, SB-450 or SB-650



4

B.) Tools and Materials Required



- **Bullet Level**
- **Flat Screwdriver**
- **Screws & Anchors**
- **Voltage Meter**
- **Drill & Drill bits**
- **Phillips Screwdriver**
- **Utility Knife**
- **Wire Stripper**

C.) Site Survey

Basic overview - Installation of the **ScaleBlaster** commercial model involves mounting the power box /computer on a wall near an electrical outlet and a signal cable that is wrapped around the incoming water supply line going to the building or equipment (boiler, chiller, laundry, dishwasher, etc.). You will need to locate a section of straight pipe of about 18 inches, and a location to mount the control box that is near an electrical outlet. This signal cable must be within 10 feet of the control box – no matter what.



C.) Site Survey (Continued)

Type of Pipe - This **ScaleBlaster** commercial model will work on PVC, PEX or copper pipe up to:
two (2) inches in diameter for the SB-250,
three (3) inches in diameter for the SB-350,
four (4) inches in diameter for the SB-450,
eight (8) inches in diameter for the SB-650.

If the pipe is galvanized or magnetic pipe, the unit will not penetrate it and will not work. By magnetic pipe, we mean that if you put a magnet on the pipe and it sticks, it is magnetic. The pipe may be stainless steel, or steel and appear to be magnetic, but not magnetic. So please test with a magnet to make sure if there is any doubt. **THIS IS EXTREMELY IMPORTANT.**

If you only have galvanized or steel pipe to install the unit on, there are two options. You can replace about a foot or so of the pipe with either copper or pvc. If this is not possible, then a much larger **ScaleBlaster** model will be required to work on this application. Consult your dealer or **Clearwater Enviro Tech** for more details.

Location of the install - The exact location of the install depends on the application. Because **ScaleBlaster** has nearly 100 various applications, it is impossible to list them all. However, the most desirable place to install the equipment is at the main water supply line going to the building or in front of the equipment. If the system has recycled water, you can also place the equipment on that line. It is best to consult your dealer or **Clearwater Enviro Tech** if you have any questions. Your main goal is to treat 100% of the water as often as possible. The unit should stay on 24 hours a day.

The unit may be installed indoors or outdoors, as the unit is in a weatherproof, UL, CUL and CE listed enclosure. If outdoors, make sure the install area is out of direct sunlight. In extremely hot or cold areas of the world, it may be best to enclose our power box / computer in another box to protect the LCD window and other inside components.

The power unit shall be mounted on a wall or solid surface within 5 ½ feet from an electrical outlet (or power source), and within ten (10) feet from the pipe in which the signal cable will be wrapped. If the power unit has to be more than 10 feet of where the signal cable will be wrapped, you should contact your dealer or call **Clearwater Enviro Tech** for assistance.

The **ScaleBlaster** unit has a 115 VAC power plug on the end of the cord. If the outlet is 230 VAC, you can simply remove the power plug and wire it to the power source. The unit will automatically adjust to 115 or 230 VAC with no adjustments required to the power box / computer.

Once the main water line (or line in front of the equipment) is located, identify a **SECTION OF STRAIGHT PIPE THAT IS AT LEAST 18 INCHES LONG**, and at least one foot away from any major electrical interference (an electric motor, for example). This straight section must be away from elbows, couplings, tees and valves. Any agitation in the water will make it difficult to properly hit the water with the **ScaleBlaster** signal. If you locate a section of straight pipe, make sure it is away from the elbows, couplings, etc. as much as possible – but if you have no other options and there are elbows or couplings close by, go ahead and install the equipment.

It is better to add an extension cord to the power cable than it is to try and increase the coil leads.

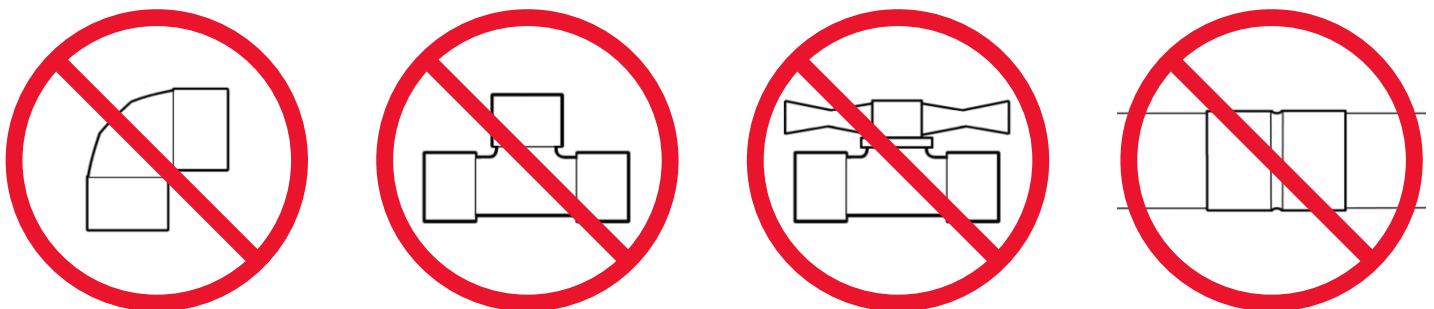

D.) Mounting the Power Box

Mount the power box / computer to the wall after drilling the four holes in the determined location. Use the appropriate screws and anchors (if needed) depending on the surface (wood, stucco, etc.). **This shall be within 5 ½ feet of a power source and 10 feet of the location for the signal cable.**

The unit can be installed indoors or outdoors as long as it is **out of direct sunlight**. The unit will work on either 115 VAC or 230 VAC with no adjustments. You can either plug the unit in a 115 VAC power outlet, or wire it directly into a 230 VAC source by removing the power plug. We strongly recommended a licensed electrician if wiring to 230 VAC.

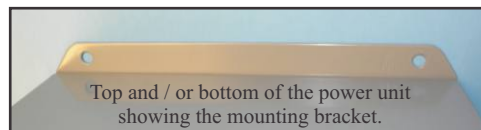
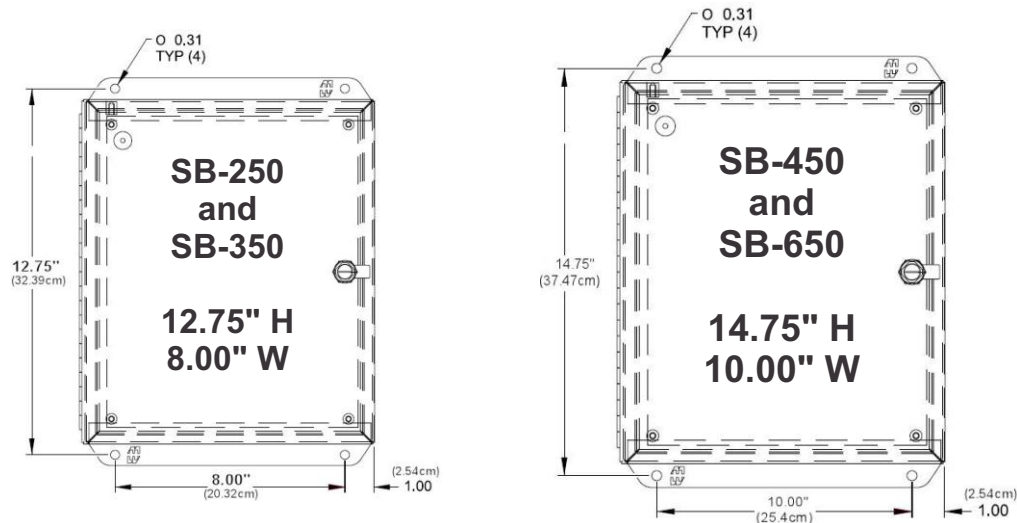

E.) Installing the Signal Cable

This model is designed specifically for commercial use, and will not work on galvanized or magnetic pipe. You may need to replace a small section of pipe where the signal cable is to be installed if it is a ferrous based pipe. You can replace it with copper or pvc pipe. There is no need to replace the galvanized pipe downstream, as the **ScaleBlaster** will descale the pipes from that point forward (from the location of where the signal cable is wrapped).

This unit is equipped with a roll of 18 or 12 awg signal cable. The maximum pipe size the unit will work on is indicated in the chart on the next page.

- 1.) Carefully strip off 2" (51mm) of the outer rubber shield from one of the ends of the signal cable. Tighten the bare wires together to get rid of any stray strands.
- 2.) Unscrew one of the two receptacle posts located on the **ScaleBlaster** power box / computer. It does not matter if you use the red or black receptacle first.
- 3.) Then insert the spliced wire of the signal cable end completely through the opening. Tighten the receptacle post as much as possible.
- 4.) It is very important you have a tight connection and that all wire threads go through the opening in the receptacle.
- 5.) Route the signal cable from the control box to the inlet pipe. Hold the cable parallel and against the pipe and then secure the cable to the pipe with one of the nylon cables ties. Make sure the tie is pulled tightly so that the cable is well attached to the pipe. Remove excess cable tie with scissors.
- 6.) Using finger pressure to keep the signal cable and tie from moving, begin wrapping the signal cable securely around the pipe in any direction. The correct number of wraps depends on pipe size and composition.
- 7.) Once the wrapping is complete, secure the signal cable to the pipe, using another enclosed cable tie. Remove the excess cable tie with scissors or cutters.
- 8.) Route the loose end of the signal cable back to the control box. Trim the cable wire to length, getting rid of any excess wire. You want to get the wire from the pipe to the power box / computer as taut as possible.

DO NOT ALLOW THE WIRES GOING TO THE CONTROL BOX - TO AND FROM THE WRAPPED COIL - TO OVERLAP OR TOUCH EACH OTHER

- 9.) Carefully strip the outer plastic shield from the other end of the signal cable, leaving about two inches of bare cable. Twist the bare cable and insert the end into the unused receptacle post (either red or black). Tighten the receptacle post. Again, make sure all threads have passed through the opening for a 100% connection.

E.) Installing the Signal Cable (continued)

IT IS IMPERATIVE TO WRAP THE COIL THE CORRECT NUMBER OF TIMES. PLEASE SEE CHART BELOW FOR CORRECT NUMBER OF WRAPS.

UNIT TYPE	Pipe Type	Pipe Size	Type of Coil	Wire Gauge	Wraps
SB-250	Copper Pipe	2"	Double	18	30
SB-250	PVC/PEX	1.5"	Single	18	40
SB-250	PVC/PEX	2"	Single	18	40
SB-250	Ferrous Pipe	Call	Call	18	Call
SB-350	Copper Pipe	2"	Double	12	68
SB-350	Copper Pipe	2.5"	Double	12	64
SB-350	Copper Pipe	3"	Double	12	60
SB-350	PVC/PEX	2"	Single	12	82
SB-350	PVC/PEX	2.5"	Single	12	71
SB-350	PVC/PEX	3"	Single	12	61
SB-350	Ferrous Pipe	Call	Call	12	Call
SB-450	Copper Pipe	3"	Double	12	60
SB-450	Copper Pipe	3.5"	Double	12	58
SB-450	Copper Pipe	4"	Double	12	56
SB-450	PVC/PEX	3"	Single	12	60
SB-450	PVC/PEX	3.5"	Single	12	52
SB-450	PVC/PEX	4"	Single	12	40
SB-450	Ferrous Pipe	Call	Call	12	Call
SB-650	Copper Pipe	4"	Double	12	56
SB-650	Copper Pipe	5"	Double	12	46
SB-650	Copper Pipe	6"	Double	12	40
SB-650	PVC/PEX	4"	Single	12	40
SB-650	PVC/PEX	5"	Single	12	33
SB-650	PVC/PEX	6"	Single	12	25
SB-650	PVC/PEX	8"	Single	12	20
SB-650	Ferrous Pipe	Call	Call	12	Call

JUST BECAUSE YOU HAVE EXTRA WIRE DOES NOT MEAN YOU HAVE TO USE IT! DO NOT OVER WRAP THE COILS MORE THAN THE RECOMMENDED NUMBER. DO NOT UNDER WRAP THE AMOUNT OF COILS SUGGESTED. Over wrapping can significantly decrease the power of the signal. If you are unable to obtain correct number of wraps due to straight pipe issues of not giving you enough space, the minimum number of wraps the unit requires is at least 30 wraps.

MAKE SURE THE WRAPS ARE FLUSH AGAINST ONE ANOTHER – NEVER OVERLAPPING. THIS IS EXTREMELY IMPORTANT.

AS PREVIOUSLY NOTED, MAKE SURE THE CONTROL BOX IS MOUNTED AS CLOSE AS POSSIBLE TO WHERE THE SIGNAL CABLE IS WRAPPED ON THE PIPE. THE MAXIMUM DISTANCE SHOULD NOT BE MORE THAN 10 FEET.

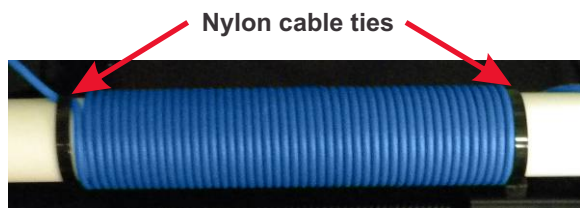

Example of a properly wrapped pipe. No gaps or loose wire wrappings allowed!

YOU MUST KEEP THE SECOND WRAPPING IN THE SAME DIRECTION AS THE FIRST! Wrap right over the top of the first layer continuing in the same wrapping direction as the first layer – clockwise or counterclockwise. This second layer must also be tight and touching the prior wrap. (Figure C)

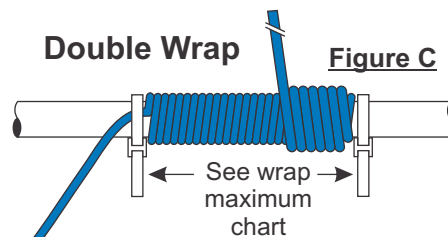

Wrap a third cable tie around the pipe and both wires. Pull the cable tie tight. (Figure D)

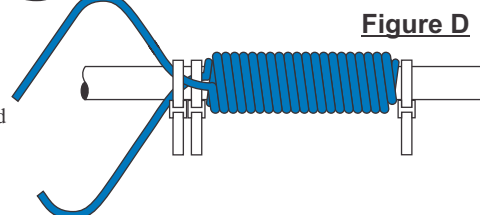

F.) Powering up the Control Box / Computer

- 1.) The unit will work automatically on either 115 or 230 VAC, however the unit has a 115 VAC power plug on the end. You may simply plug this into a 115 VAC outlet. Since electrical outlets vary worldwide, or if you need 230VAC, the power cord plug may not match your outlet type. In this case, it must be replaced with the proper plug by a licensed electrician.
- 2.) Plug the power cord into the outlet.
- 3.) The unit should stay on 24 hours a day.
- 4.) Monitor the LCD screen from time to time to be sure of continuous operation.

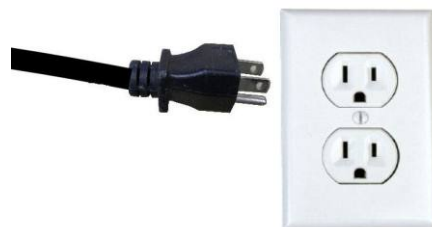

G.) LCD Indicator Screen

When the unit is operating normally it will show the screen below.
(SB-250)

OPERATIONAL

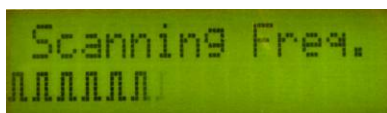

The Scanning Frequency Screen to the left indicates the unit is functioning correctly and is sweeping the full frequency range of the calcium resonance. When the **SB-350**, **SB-450** and **SB-650** are operating normally they will alternate between the two screens shown.

The screen to the right will intermittently show the coil output status in percent and the internal system temperature. **NOTE: SB-350, SB-450 and SB-650 ONLY**

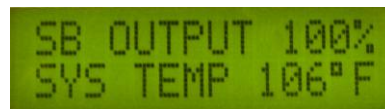

ERROR MODE

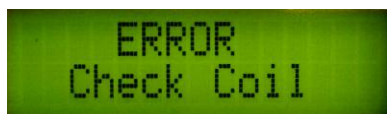

If there is an error (or the coil just isn't yet attached) the screen to the left will appear. If the coil is connected and the message to the left is present, then contact your dealer or **Clearwater Enviro Tech** for help. **(ALL UNITS)**

This screen to the right will appear if the internal temperature reaches 180 degrees Fahrenheit. At this point the unit will shut down until the temperature subsides. This can happen if you inadvertently short out the coil output for extended periods of time or mount the unit in direct sunlight. **NOTE: SB-350, SB-450 and SB-650 ONLY**

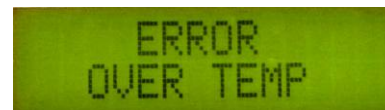

Manufactured by



8767 115th Ave. N. • Largo, FL 33773
Phone: 800-756-7946 or 727-562-5186 • Fax: 727-562-5187
clearwater-enviro.com

